

Vello 1 40 (420x480)

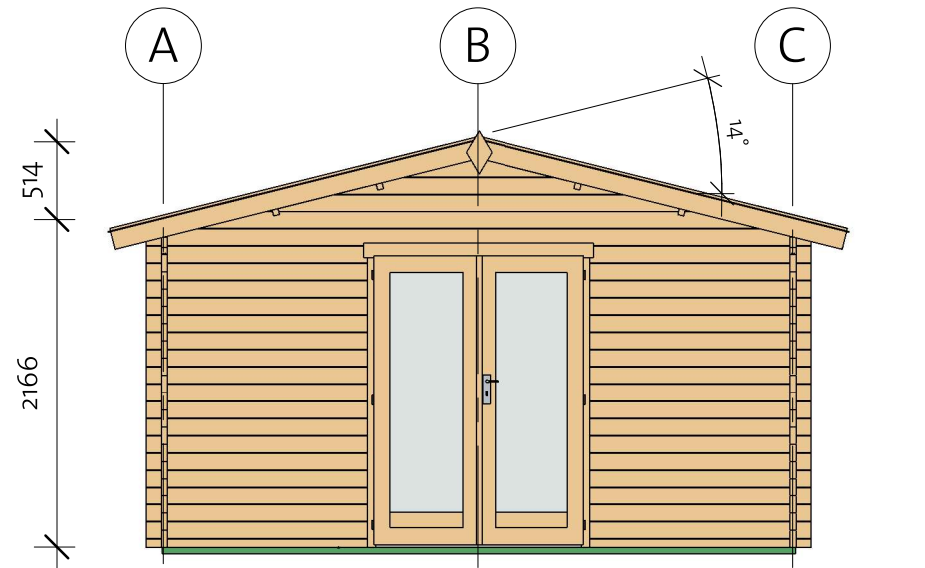

Vello 1 40 (420x480)

Foundation

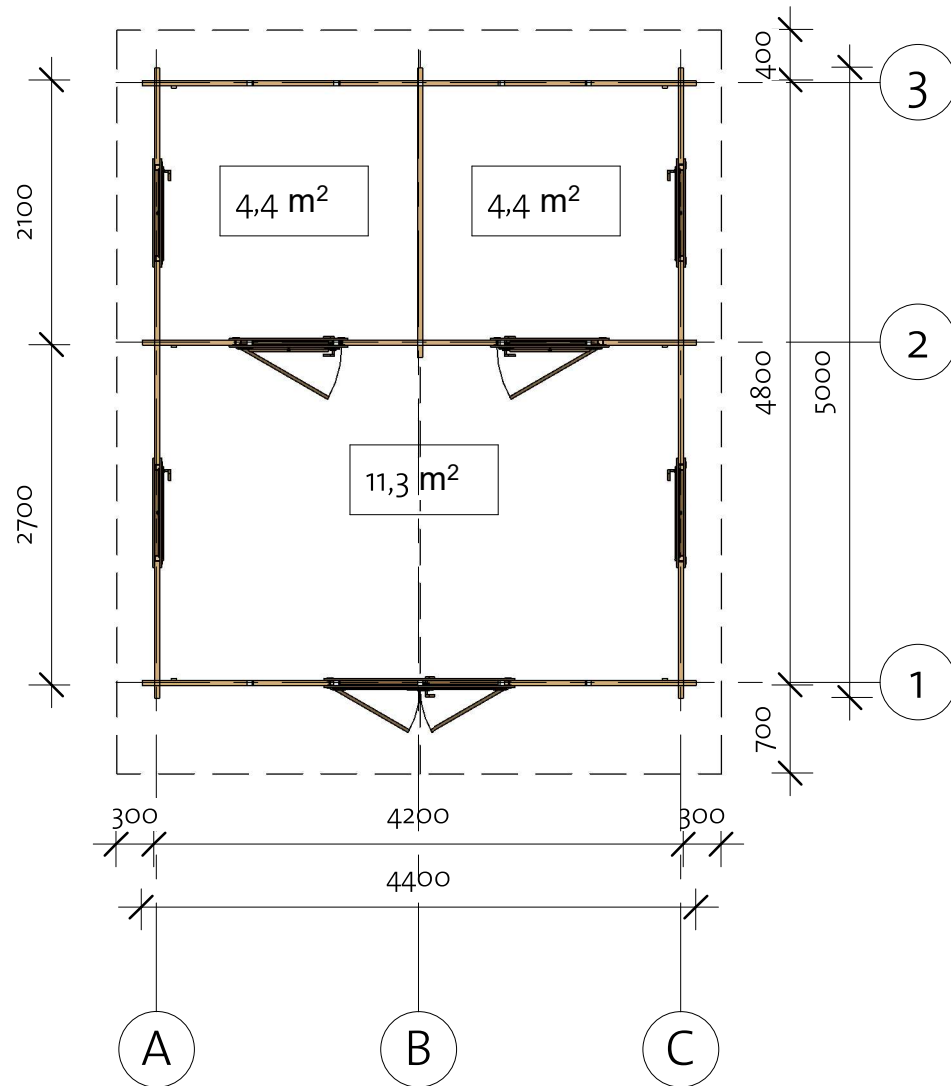
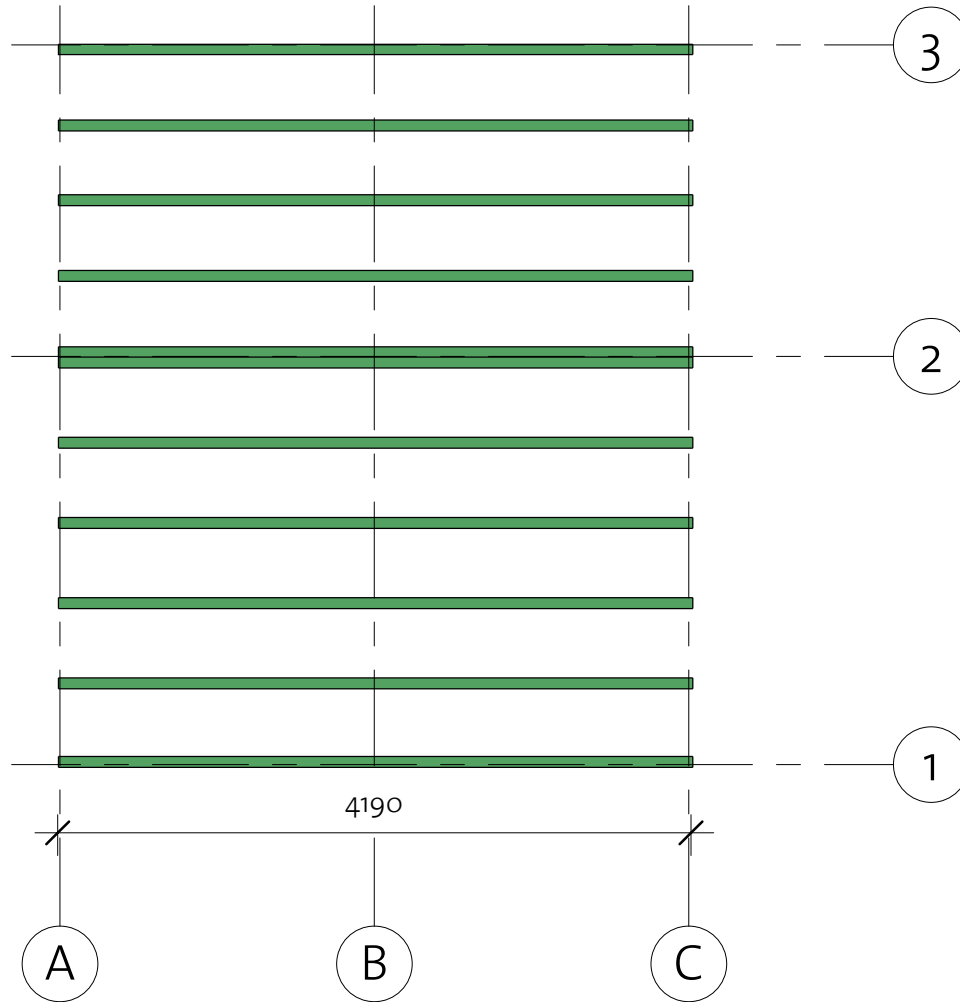

Impregnated foundation beams



Mark	Type	Profile	Count	Length
------	------	---------	-------	--------

IFB	IFB 70x40		11	4190
-----	--------------	---	----	------

Vello 1 40 (420x480)

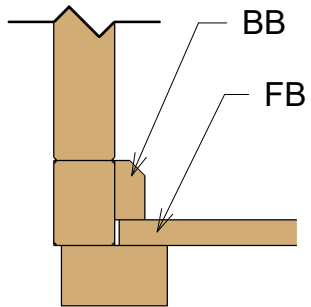
Floor Plan
1 Baseboard



Floor Schedule				
Mark	Type	Profile	Count	Length
FB1	FB 17x114		37	2654
FB2	FB 17x114		38	2014
BB1	BB 20x40		2	4800
BB2	BB 20x40		2	3800

200513

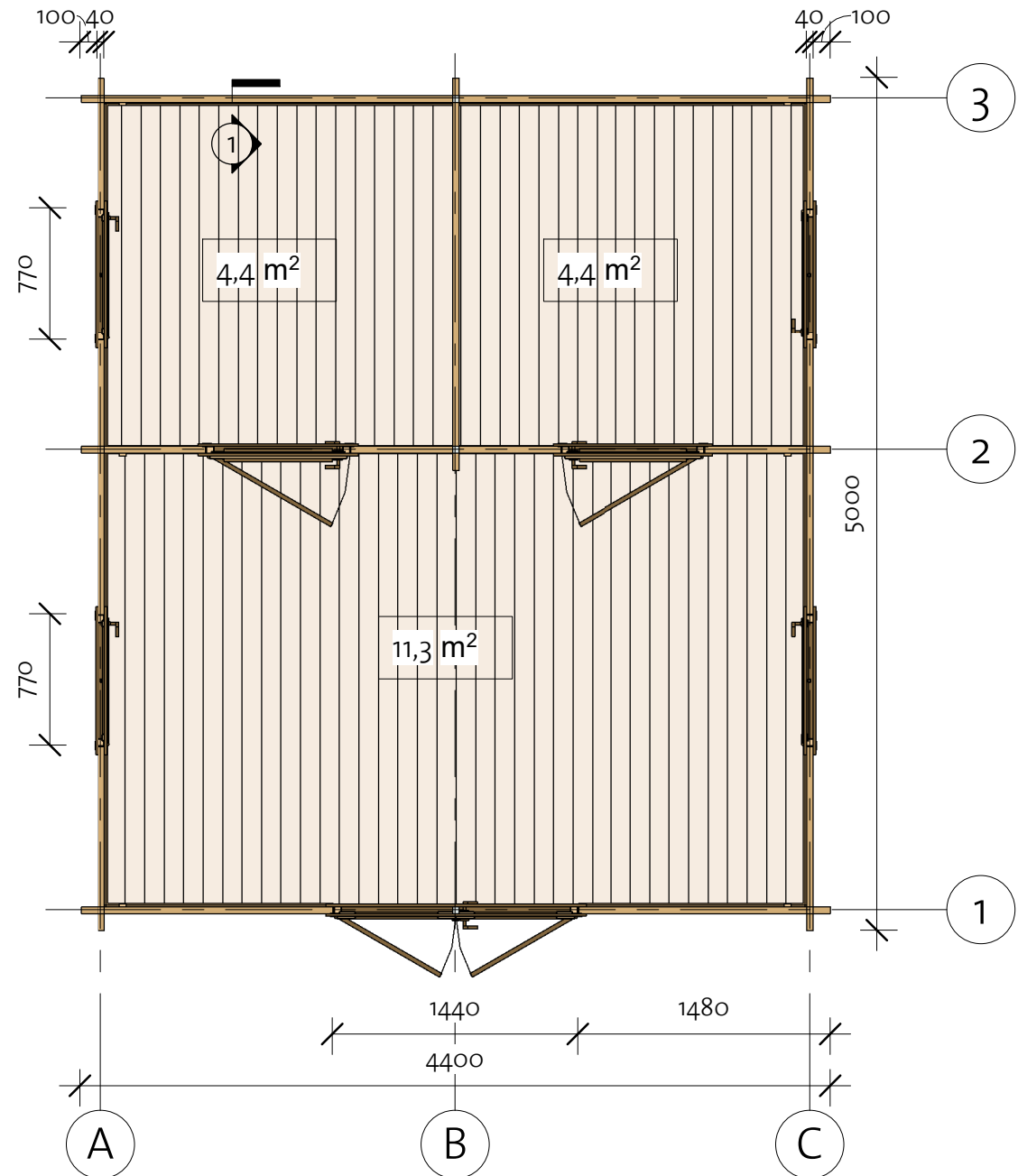

Vello 1 40 (420x480)

Wall 1

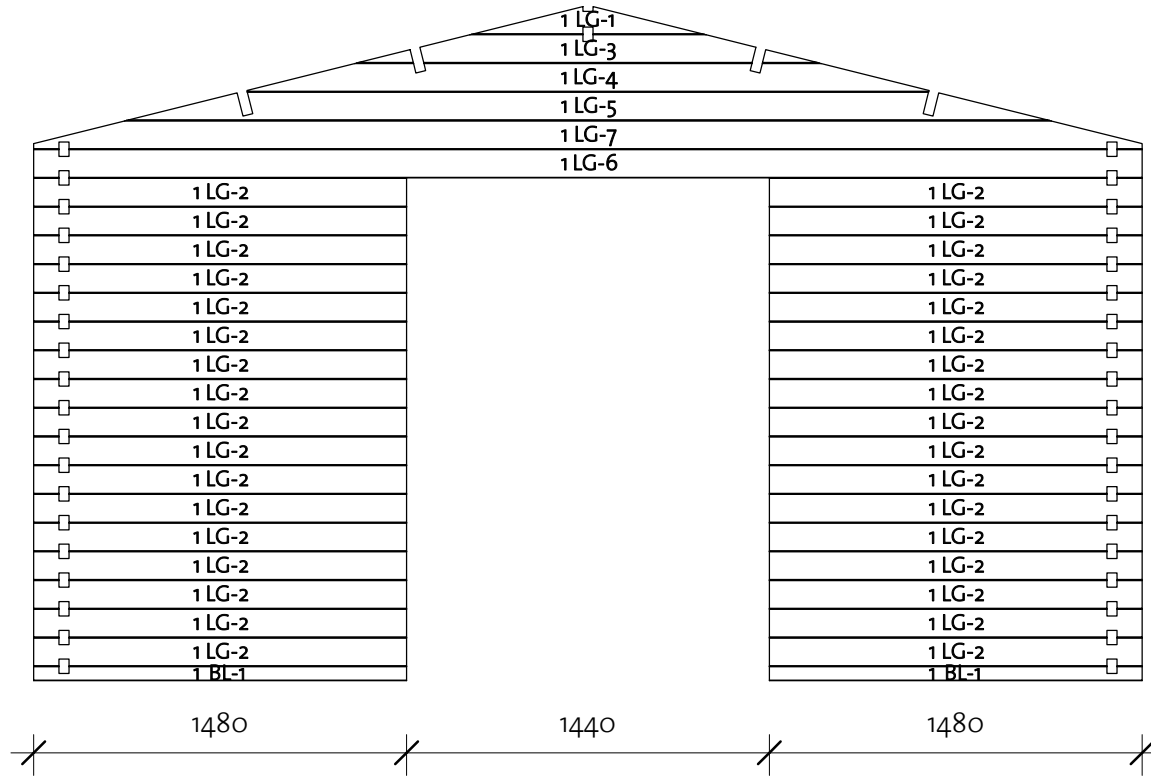
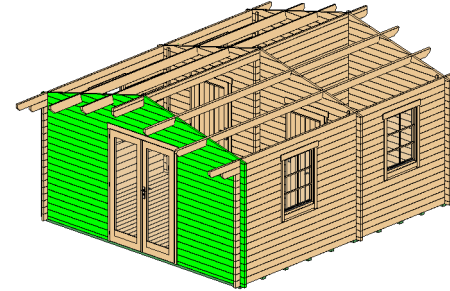

Wall 1			
Mark	Profile	Count	Cut Length

1BL-1	40x57	2	1480
1LG-1	40x114	1	922
1LG-2	40x114	34	1480
1LG-3	40x114	1	1836
1LG-4	40x114	1	2707
1LG-5	40x114	1	3663
1LG-6	40x114	1	4400
1LG-7	40x114	1	4400

Log Profile Wall 1	
Profile	Profile

40x57	
40x114	

Vello 1 40 (420x480)

Wall 2

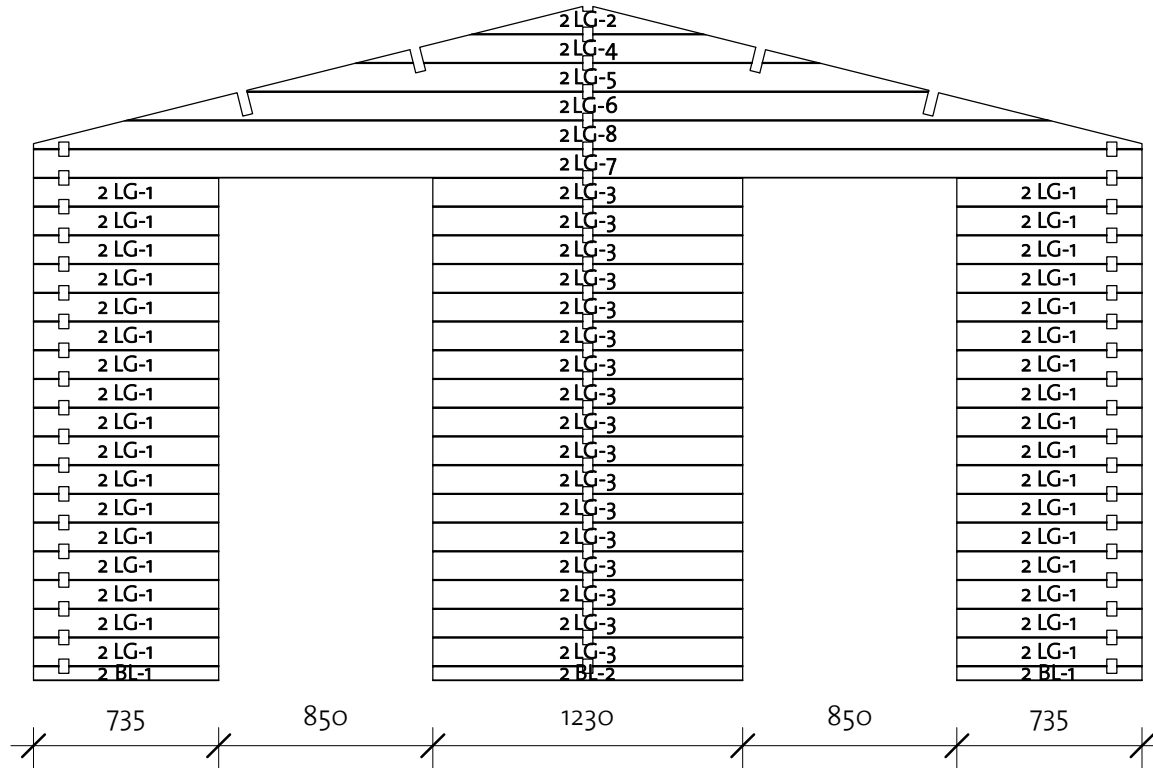
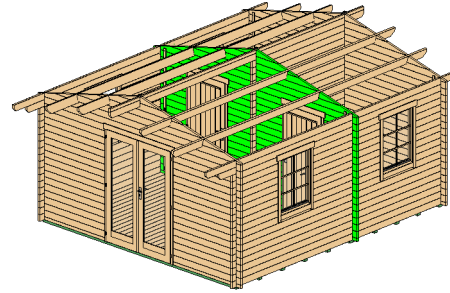

Wall 2			
Mark	Profile	Count	Cut Length

2BL-1	40x57	2	735
2BL-2	40x57	1	1230
2LG-1	40x114	34	735
2LG-2	40x114	1	922
2LG-3	40x114	17	1230
2LG-4	40x114	1	1836
2LG-5	40x114	1	2707
2LG-6	40x114	1	3663
2LG-7	40x114	1	4400
2LG-8	40x114	1	4400

Log Profile Wall 2	
Profile	Profile

40x57	
40x114	

Vello 1 40 (420x480)

Wall 3

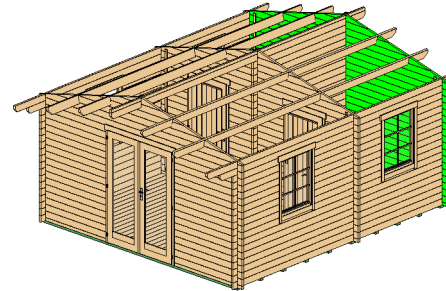

Wall 3			
Mark	Profile	Count	Cut Length

3BL-1	40x57	1	4400
3LG-1	40x114	1	922
3LG-2	40x114	1	1836
3LG-3	40x114	1	2707
3LG-4	40x114	1	3663
3LG-5	40x114	18	4400
3LG-6	40x114	1	4400

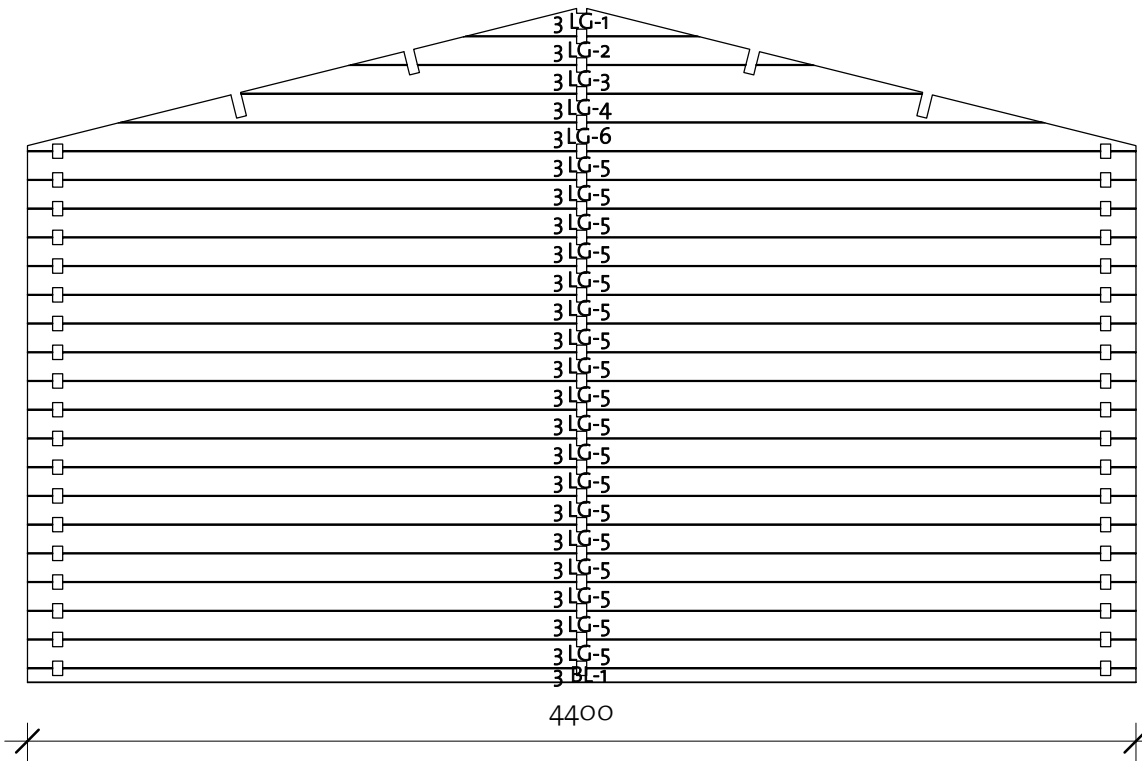

Log Profile Wall 3	
Profile	Profile

40x57	
40x114	

Vello 1 40 (420x480)

Wall A

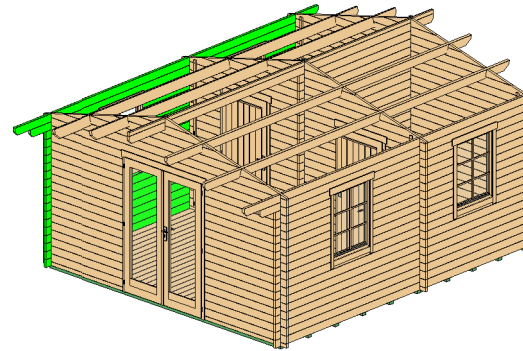

Wall A			
Mark	Profile	Count	Cut Length

ALG-1	40x114	9	763
ALG-2	40x114	9	1083
ALG-3	40x114	9	1605
ALG-4	40x114	8	5000
ALG-5	40x114	1	5300
ATL-1	40x114	1	5900

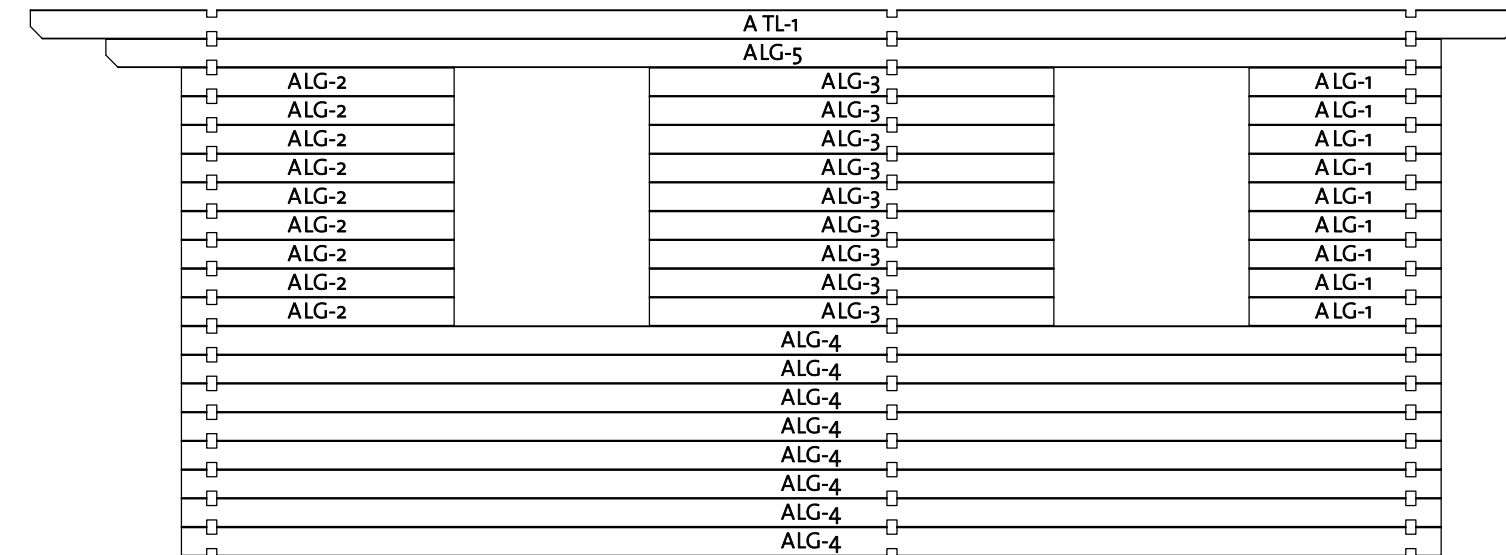

Log Profile Wall A	
Profile	Profile

40x114	
40x114	

Vello 1 40 (420x480)

Wall B

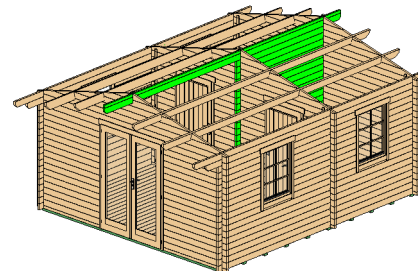

Wall B			
Mark	Profile	Count	Cut Length

BLG-1	40X114	22	2300
BLG-2	40X114	1	5900
BTL-1	40X58	1	5900

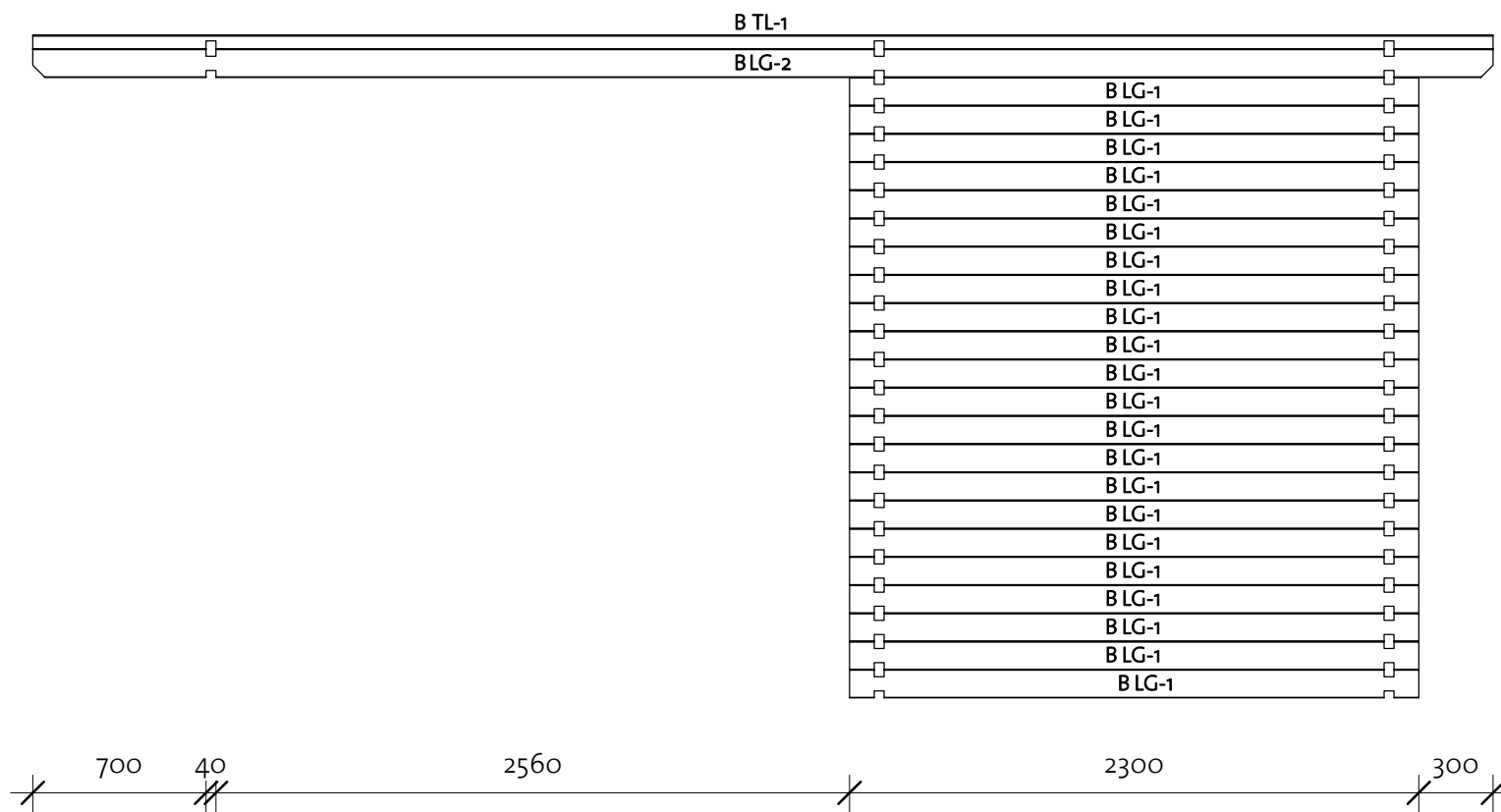

Log Profile Wall B	
Profile	Profile

40X114	
40X58	

Vello 1 40 (420x480)

Wall C

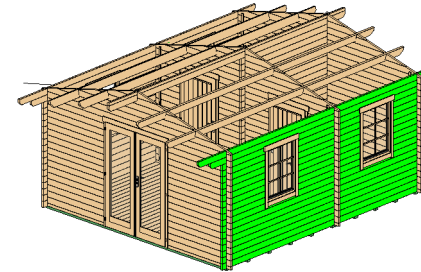

Wall C			
Mark	Profile	Count	Cut Length

CLG-1	40x114	9	763
CLG-2	40x114	9	1083
CLG-3	40x114	9	1605
CLG-4	40x114	8	5000
CLG-5	40x114	1	5300
CTL-1	40x114	1	5900

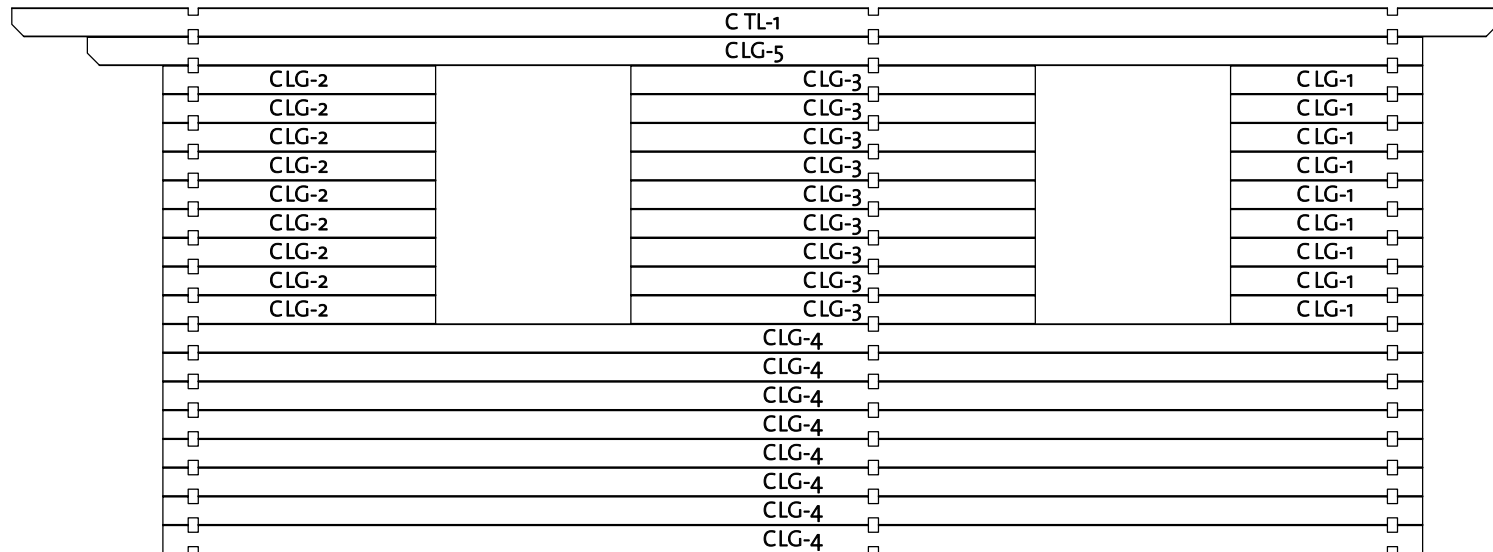



Log Profile Wall C	
Profile	Profile

40x114	
40x114	

Vello 1 40 (420x480)

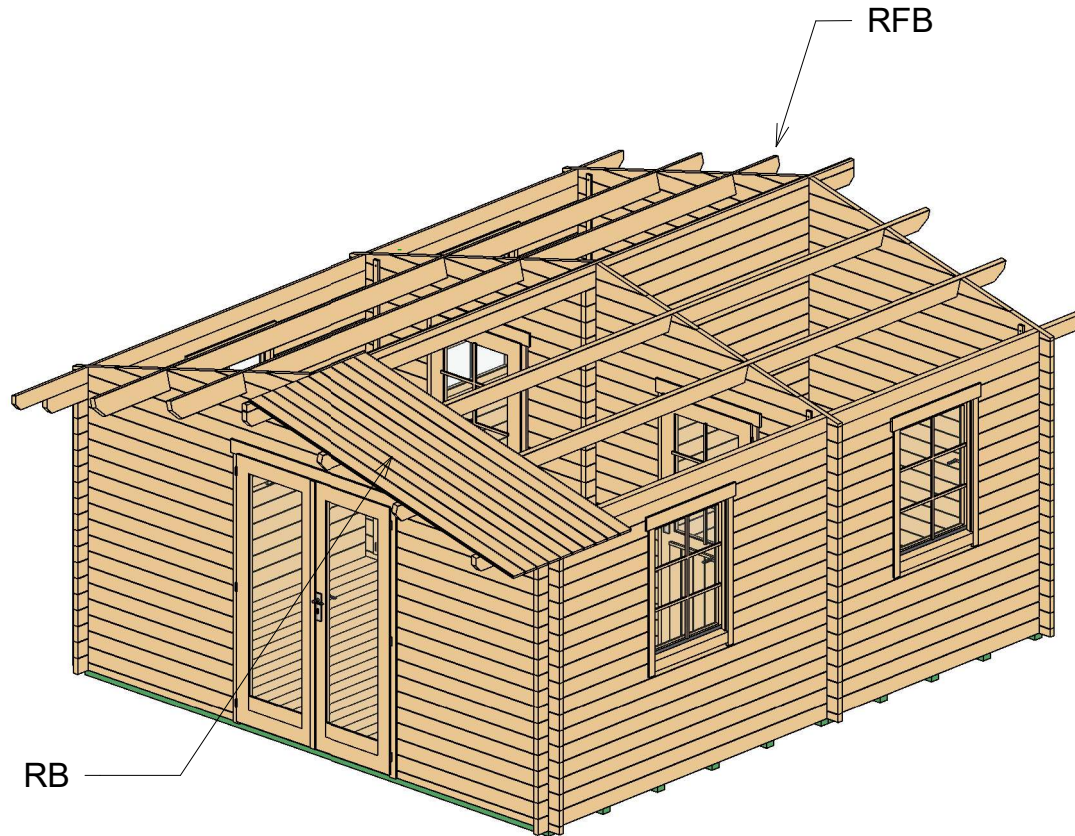
Roof 1



Roof				
Mark	Type	Profile	Count	Length
RFB	Beam 40x143		4	5900
RB	17x114		106	2469

Vello 1 40 (420x480)

Roof 2

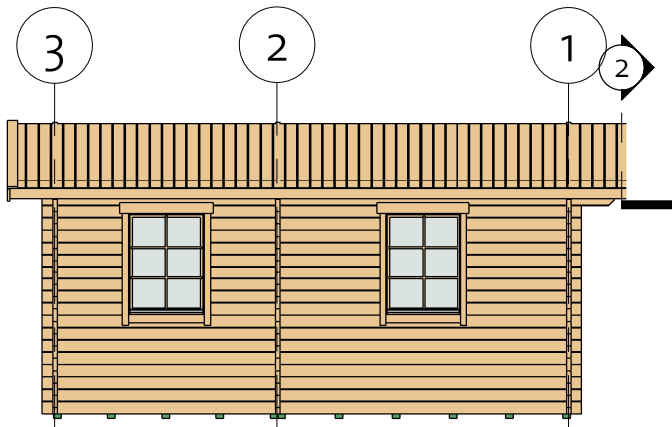

② Fascia

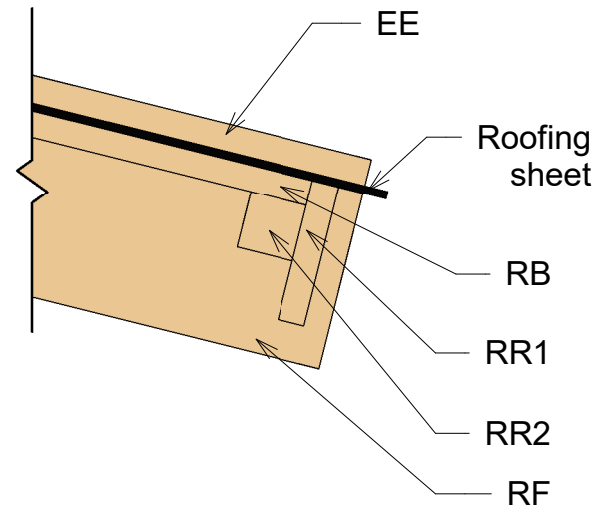

Fascia Schedule				
Mark	Type	Profile	Count	Length

EE	Eave Edging 18x95		4	2508
RF	Roof Fascia 18x120		4	2508
RR1	Roof reinforcement 18x95		2	5900
RR2	Roof reinforcement 38x38		2	5900

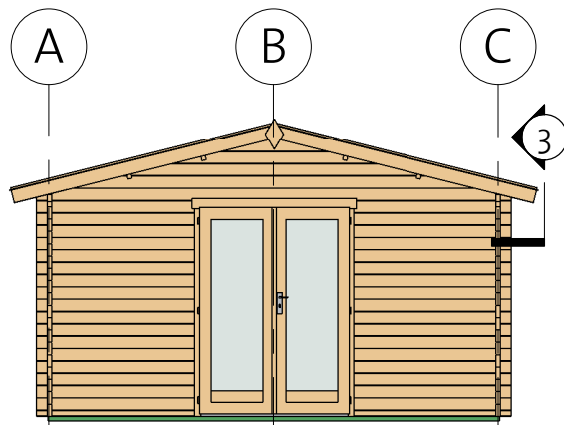

③ Roof Reinforcement

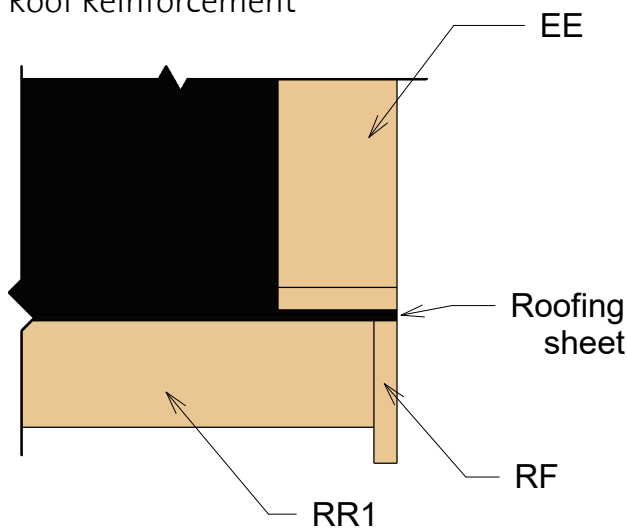

Vello 1 40 (420x480)

Extras



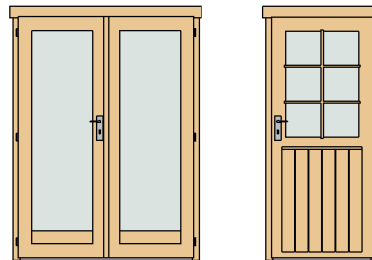

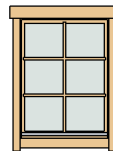

CDD3R	Classic double door 3, full glass right	1425	1955	1
CD4R	Classic door 4 right	840	1955	1
CD4L	Classic door 4 left	840	1955	1



CW1L	Classic window 1 left	765	990	2
CW1R	Classic window 1 right	765	990	2



WCB6	Windows Crossbar 6	--	--	4
------	--------------------	----	----	---

Hitblock	300-400 mm		
Bolts	M8 x 70		18
Screws	5,0 x 70		30
Screws	6,0 x 140		40
Nails	1,4 x 40		40
Screws	4,0 x 40		95
Screws	4,0 x 50		740

Romb	2
------	---

Windboard		
Type	Count	Length

Windboard 18x40	6	2200
-----------------	---	------

Vello 1 40 (420x480)

List of all items 1

Impregnated foundation beams

Mark	Type	Profile	Count	Length
------	------	---------	-------	--------

IFB	IFB 70x40		11	4190
-----	--------------	---	----	------

BB1	BB 20x40		2	4800
-----	-------------	---	---	------

BB2	BB 20x40		2	3800
-----	-------------	--	---	------

Floor Schedule

Mark	Type	Profile	Count	Length
------	------	---------	-------	--------

FB1	FB 17x114		37	2654
-----	-----------	---	----	------

FB2	FB 17x114		38	2014
-----	-----------	--	----	------

Roof

Mark	Type	Profile	Count	Length
------	------	---------	-------	--------

RFB	Beam 40x143		4	5900
-----	----------------	---	---	------

RB	17x114		106	2469
----	--------	---	-----	------

Fascia Schedule

Mark	Type	Profile	Count	Length
------	------	---------	-------	--------

EE	Eave Edging 18x95		4	2508
----	-------------------------	---	---	------

RF	Roof Fascia 18x120		4	2508
----	--------------------------	---	---	------

RR1	Roof reinforce ment 18x95		2	5900
-----	------------------------------------	---	---	------

RR2	Roof reinforce ment 38x38		2	5900
-----	------------------------------------	---	---	------

Vello 1 40 (420x480)

List of all items 2

Wall 1			
Mark	Profile	Count	Cut Length

1BL-1	40X57	2	1480
1LG-1	40X114	1	922
1LG-2	40X114	34	1480
1LG-3	40X114	1	1836
1LG-4	40X114	1	2707
1LG-5	40X114	1	3663
1LG-6	40X114	1	4400
1LG-7	40X114	1	4400

Wall 2			
Mark	Profile	Count	Cut Length

2BL-1	40X57	2	735
2BL-2	40X57	1	1230
2LG-1	40X114	34	735
2LG-2	40X114	1	922
2LG-3	40X114	17	1230
2LG-4	40X114	1	1836
2LG-5	40X114	1	2707
2LG-6	40X114	1	3663
2LG-7	40X114	1	4400
2LG-8	40X114	1	4400

Wall 3			
Mark	Profile	Count	Cut Length

3BL-1	40X57	1	4400
3LG-1	40X114	1	922
3LG-2	40X114	1	1836
3LG-3	40X114	1	2707
3LG-4	40X114	1	3663
3LG-5	40X114	18	4400
3LG-6	40X114	1	4400

Wall B			
Mark	Profile	Count	Cut Length

BLG-1	40X114	22	2300
BLG-2	40X114	1	5900
BTL-1	40X58	1	5900

Wall A			
Mark	Profile	Count	Cut Length

ALG-1	40X114	9	763
ALG-2	40X114	9	1083
ALG-3	40X114	9	1605
ALG-4	40X114	8	5000
ALG-5	40X114	1	5300
ATL-1	40X114	1	5900

Wall C			
Mark	Profile	Count	Cut Length

CLG-1	40X114	9	763
CLG-2	40X114	9	1083
CLG-3	40X114	9	1605
CLG-4	40X114	8	5000
CLG-5	40X114	1	5300
CTL-1	40X114	1	5900